



Click!

# L.BOX LD OFFER OFFRE DÉCOUVERTE L.BOX LD



Select your language  
Sélectionnez votre langue



EN 

FR 

CZ 

ES 

DE 



IT 

POL 











You purchased a VMAX XV or VMAX XV-D...

Lacmé thanks you for your confidence and congratulates you on having opted for a Connect'LD energizer !

Connect'LD means that it is compatible with the L.BOX LD, the latest Lacmé innovation !

Clearly, new possibilities are available to you, all using your smartphone :

- Remotely control (on/off) your energizer
- View at any time the voltage supplied by your energizer
- Be alerted in the event of a failure in your installation
- And many other features to discover !
- Free to use, without subscription



FREE "LBOXLD" App



**WE OFFER YOU THE L.BOX LD !**

## HOW TO TAKE ADVANTAGE OF THE OFFER ?

- 1** Scan the QR code below or go to [www.lc1.fr/vbr](http://www.lc1.fr/vbr)
- 2** fill in your details on the online form
- 3** Receive your **L.BOX LD FREE** and profit from the **NEW SERVICES**



***Valid to December 31, 2025***

### How your Connect'LD energizer works with the L.BOX LD

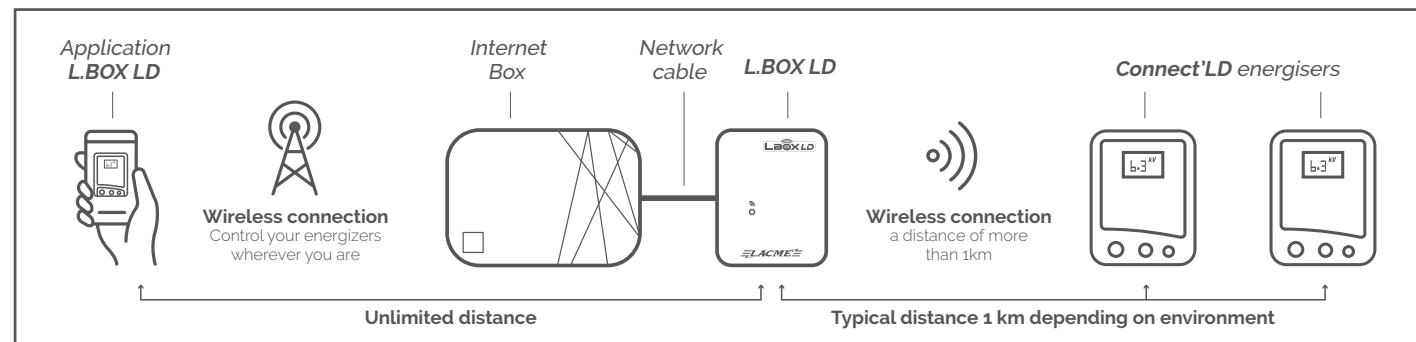

- EN
- FR
- CZ
- ES
- DE
- IT
- POL

Lacmé vous remercie de votre confiance et vous félicite d'avoir opté pour un électrificateur de type Connect'LD!

Connect'LD signifie qu'il est compatible avec la L.BOX LD, la dernière innovation Lacmé!

En clair, de nouvelles possibilités s'offrent à vous, le tout à l'aide de votre smartphone :

- ✓ Télécommander (marche/arrêt) votre électrificateur à distance
- ✓ Être alerté en cas de défaillance de votre installation
- ✓ Utilisation gratuite, sans abonnement
- ✓ Visualiser à tout moment la tension fournie par votre électrificateur
- ✓ Et bien d'autres fonctionnalités à découvrir !



Application "LBOXLD" GRATUITE



## ON VOUS OFFRE LA L.BOX LD !

### COMMENT PROFITER DE L'OFFRE ?

- 1 Flashez le QR code ci-dessous ou rendez vous sur [www.lc1.fr/vbr](http://www.lc1.fr/vbr)
- 2 Renseignez vos coordonnées sur le formulaire en ligne
- 3 Recevez votre L.BOX LD et profitez de tous nos nouveaux SERVICES GRATUITS !



*Valable jusqu'au 31 décembre 2025*

### Mode de fonctionnement de votre électrificateur Connect'LD avec la L.BOX LD

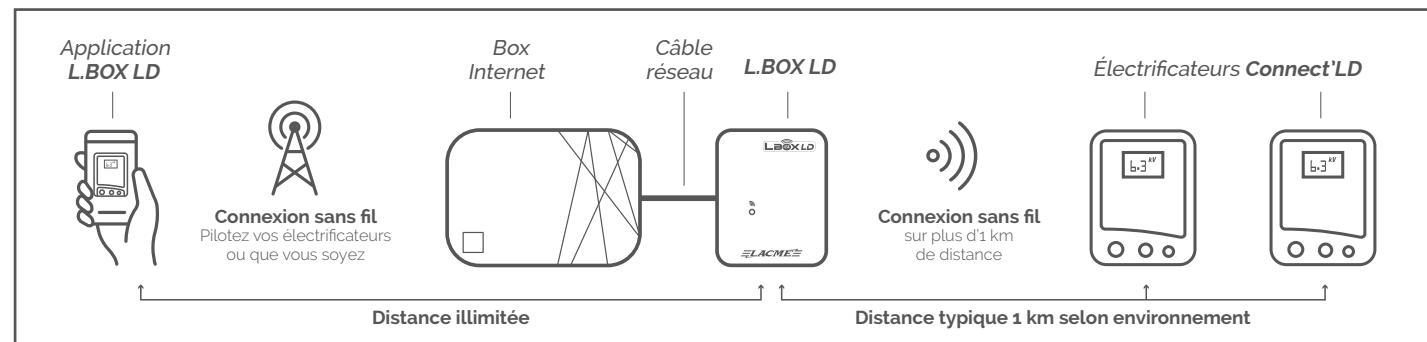

- EN
- FR
- CZ
- ES
- DE
- IT
- POL

Zakoupili jste VMAX XV nebo VMAX XV-D...

Děkujeme za vaši důvěru a blahopřejeme k výběru energizéru Connect'LD!

Connect'LD znamená, že je kompatibilní s L.BOX LD, nejnovější inovací Lacmé!

Pro váš smartphone jsou k dispozici nové možnosti:

- Dálkové ovládání (zapnuto/vypnuto) vaše energizér
- Zobrazit v libovolném časovat napětí dodané vašim energizér
- Budte upozorněni na a tvé selhání instalace
- A mnoho dalších funkcí k objevování!
- Zdarma k použití, bez předplatné

## L.BOX LD



**VOLNÝ, UVOLNIT**  
Aplikace "LBOXLD"



## NABÍZÍME VÁM L.BOX LD!

### JAK VYUŽÍT NABÍDKU ?

1

Naskenujte QR kód níže nebo přejděte na [www.lc1.fr/vbr](http://www.lc1.fr/vbr)

2

vyplnit vaše údaje online

3

Přijměte svůj **L.BOX LD** a užívejte si všech našich nových **BEZPLATNÝCH SLUŽEB!**

Click!



lc1.fr/vbr

**Platí do 31. prosince 2025**

Jak váš energizér Connect'LD funguje s L.BOX LD

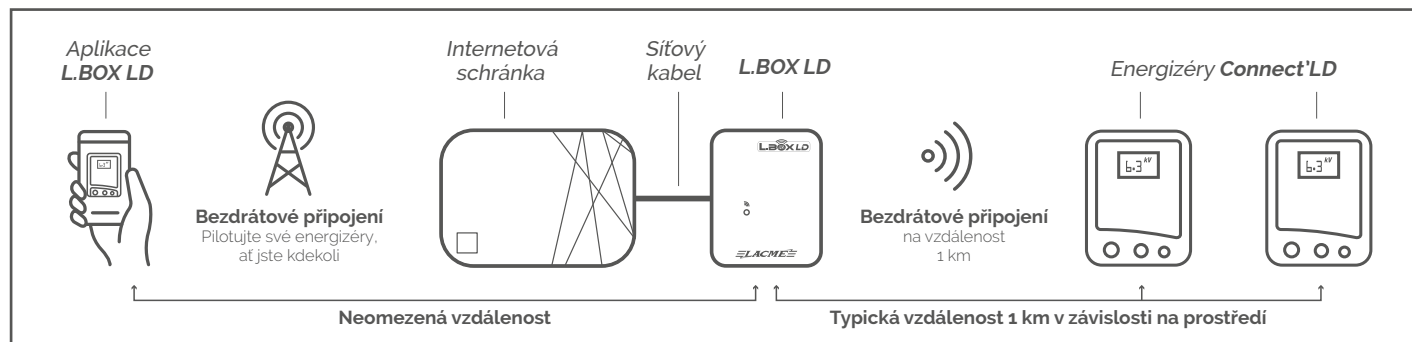

EN



ES



IT



FR



DE



POL



CZ



Click!

Click!

Click!

Compró un VMAX XV o VMAX XV-D...

¡Lacmé le agradece de su confianza y le felicita por elegir un energizador Connect'LD!

Connect'LD significa que es compatible con L.BOX LD, ¡la última innovación de Lacmé!

Claramente, hay nuevas posibilidades disponibles, usando su smartphone :

- ✓ Control remoto (encendido/apagado) de su energizador a distancia
- ✓ Ser alertado en caso de falla en su instalación
- ✓ De uso gratuito, sin suscripción
- ✓ Consulta en todo momento el voltaje suministrado por su energizador
- ✓ Y muchas otras características a descubrir !



Solicitud "LBOXLD" GRATUITO



## ¡TE OFRECEMOS LA L.BOX LD!

### ¿CÓMO DISFRUTAR DE LA OFERTA?

1

Escanea el código QR abajo o ir a [www.lc1.fr/vbr](http://www.lc1.fr/vbr)

2

llenar su dirección en el formulario en línea

3

¡ Recibe tu **L.BOX LD** y benefícate de todos nuestros nuevos **SERVICIOS GRATUITOS!**



*Válido hasta el 31 de diciembre de 2025*

Cómo funciona su energizador Connect'LD con el L.BOX LD

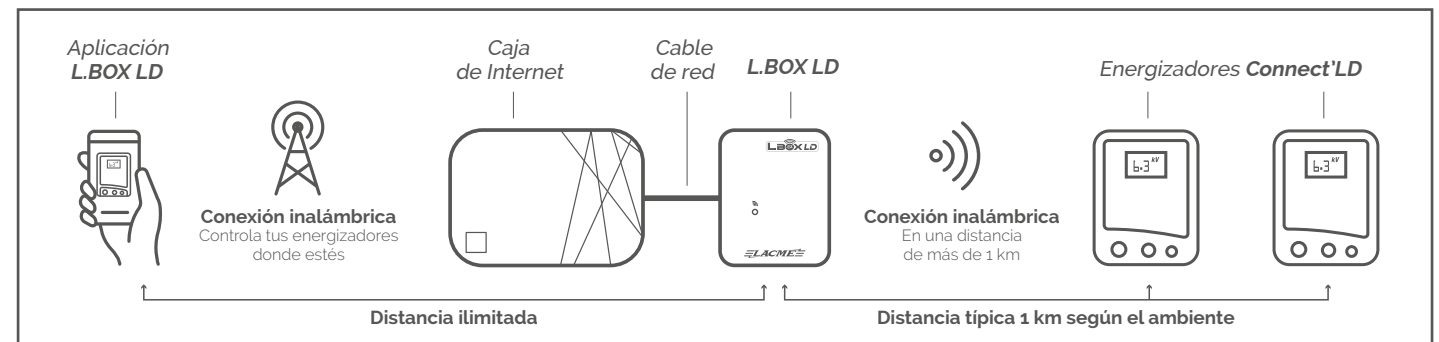

EN



ES



IT



FR



DE



POL



CZ



Click!

Click!

Click!

Sie haben eine VMAX XV oder VMAX XV-D gekauft...

**Vielen Dank für Ihr Vertrauen und herzlichen Glückwunsch, dass Sie sich für ein Connect'LD Weidezaungerät entschieden haben!**

**Connect'LD bedeutet, dass es mit der L.BOX LD, der neuesten Innovation von Lacmé, kompatibel ist!**

Für Ihr Smartphone stehen neue Möglichkeiten zur Verfügung :

- Fernsteuern (ein/aus) Ihres Weidezaungerätes
- Bei Fehlfunktion der installation alarmiert werden
- Kostenlose Nutzung ohne Vertrag
- Spannung des Geräts jederzeit sichtbar
- Und viele andere Funktionen, die es zu entdecken gilt!

### L.BOX LD



**KOSTENLOS**  
Anwendung "LBOXLD"



**WIR BIETEN IHNEN DIE L.BOX LD!**

### WIE KANN MAN DAS ANGEBOT NUTZEN?

**1**  
Scannen Sie den QR-Code unten oder gehen Sie zu [www.lc1.fr/vbr](http://www.lc1.fr/vbr)

**2**  
Geben Sie Ihre Daten auf das Online-Formular an

**3**  
Erhalten Sie Ihre **L.BOX LD**, und nutzen Sie all unsere neue **KOSTENLOSE DIENSTE!**

Click!



lc1.fr/vbr

***Gültig bis 31. Dezember 2025***

So funktioniert Ihr Connect'LD Weidezaungerät mit der L.BOX LD

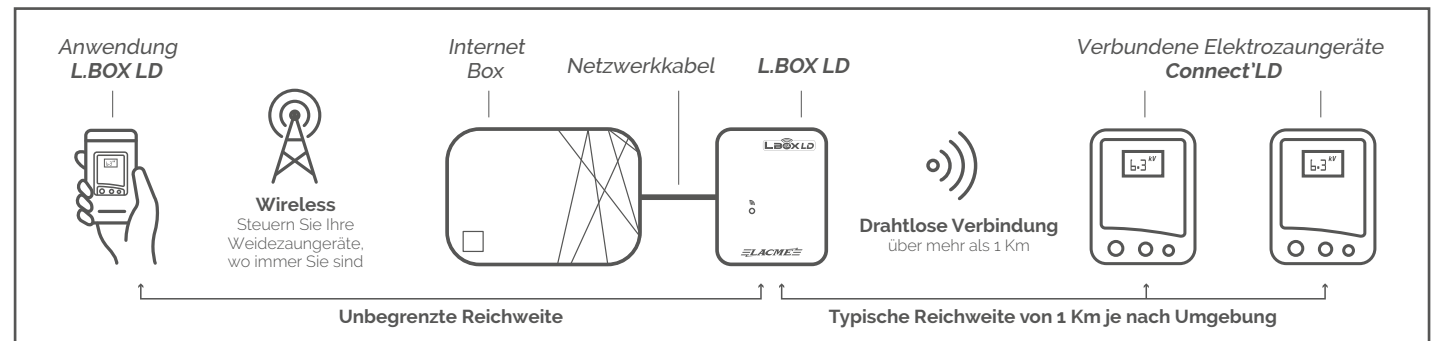

- EN ES IT
- FR DE POL
- CZ
- Click! Click! Click!

Hai acquistato un VMAX XV o VMAX XV-D...

**TI OFFRIAMO IL L.BOX LD!**

Lacmé ti ringrazia per la tua fiducia e si congratula con te per aver scelto un elettrificatore del tipo **Connect'LD!**

**Connect'LD** significa che è compatibile con **L.BOX LD**, l'ultima innovazione Lacmé!

Chiaramente, nuove possibilità sono a tua disposizione, tutte utilizzando il tuo smartphone:

- Controlla a distanza (on/off) il tuo elettrificatore da una distanza
- Essere avvisato in caso di problemi con l'installazione
- Gratuito da usare, senza abbonamento
- Visualizza in ogni momento la tensione fornita dal tuo elettrificatore
- E molte altre funzionalità scoprire!

**L.BOX LD**



Applicazione GRATIS "LBOXLD"

Disponibile sur Google Play

Disponibile sur App Store

**COME APPROPRIARE DE L' OFFERTA ?**

1

Scansiona il codice QR sotto o vai a [www.lc1.fr/vbr](http://www.lc1.fr/vbr)

2

Compilare i tuoi dettagli sul modulo online

3

Ricevi il tuo **L.BOX LD** e beneficia di tutti i nostri nuovi **SERVIZI GRATUITI!**

Click!



lc1.fr/vbr

Valido fino al 31 dicembre 2025

Come funziona il tuo elettrificatore Connect'LD con L.BOX LD

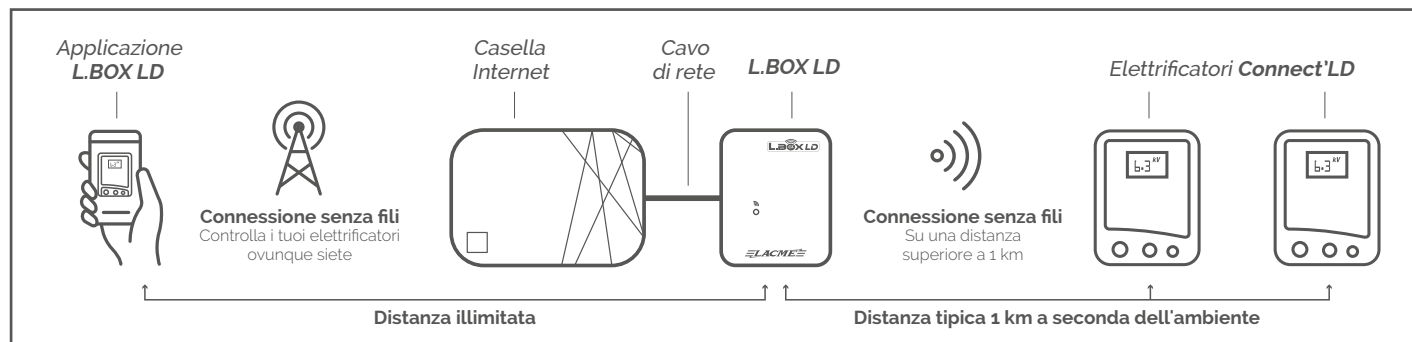

EN

ES

IT

FR

DE

POL

CZ

Click!

Click!

Click!

Lacmé dziękuje za zaufanie i gratuluje wyboru energetyzatora typu Connect'LD!

Connect'LD oznacza, że jest kompatybilny z L.BOX LD, najnowszą innowacją Lacmé!

Oczywiście masz do dyspozycji nowe możliwości, wszystkie za pomocą smartfona:

- ✓ Zdalne sterowanie (włączanie/wyłączanie) elektryzatora z odległości
- ✓ Otrzymuj powiadomienia w przypadku awarii instalacji
- ✓ Darmowy w użyciu, bez abonamentu
- ✓ Zobacz w dowolnym momencie napięcie dostarczane przez elektryzator
- ✓ I wiele innych funkcji odkrywać!



Wniosek GRATIS "LBOXLD"



**OFERUJEMY PAŃSTWU L.BOX LD!**

## JAK SKORZYSTAĆ Z OFERTY?

1

Zeskanuj kod QR poniżej lub przejdź do [www.lc1.fr/vbr](http://www.lc1.fr/vbr)

2

Wypełnić Twoje szczegóły na formularzu Internetowym

3

Odbierz **L.BOX LD** i skorzystaj z wszystkich naszych nowych **DARMOWYCH USŁUG!**

Click!



lc1.fr/vbr

*Obowiązuje do 31 grudnia 2025 roku*

Jak Twój elektryzator Connect'LD współpracuje z L.BOX LD

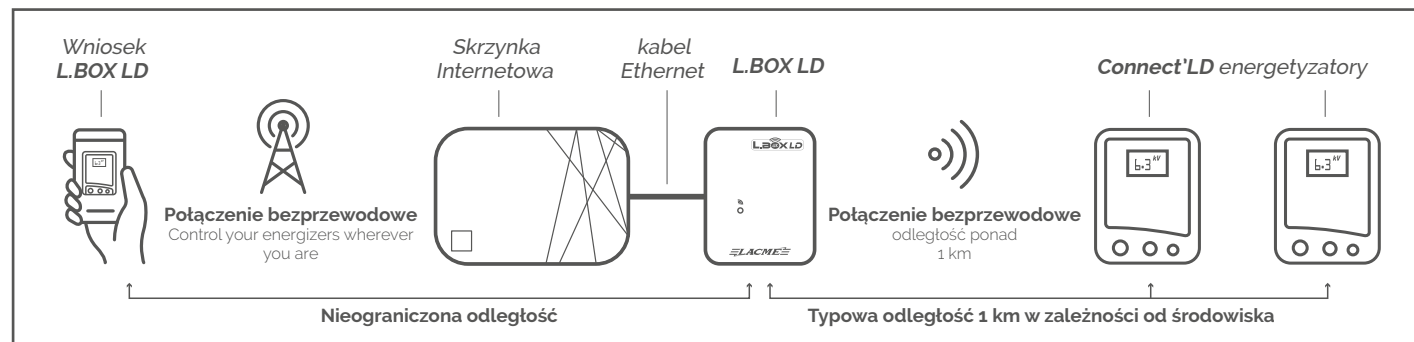

EN

ES

IT

FR

DE

POL

CZ

Click!

Click!

Click!